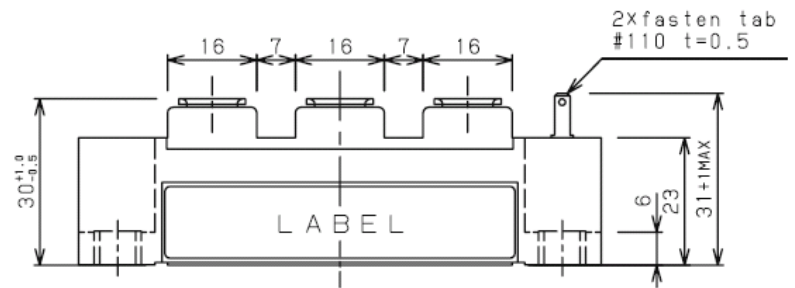
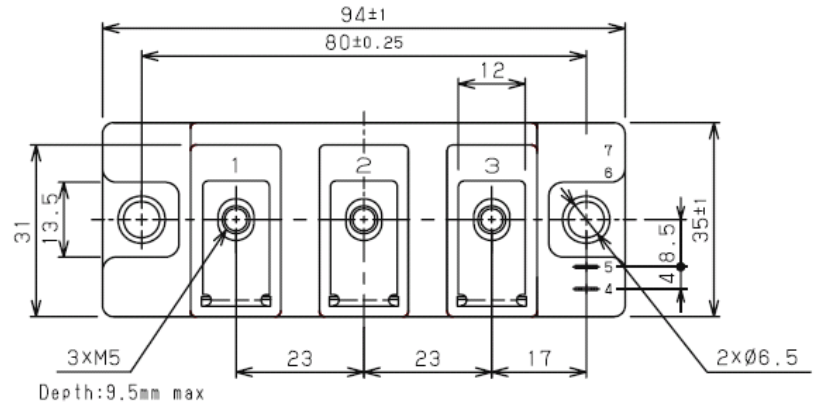
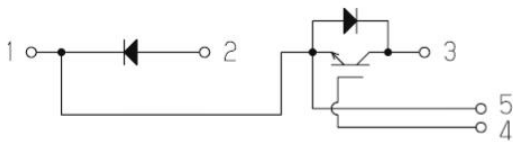

□ 回路図 : *CIRCUIT*

 □ 概略図 : *SCHEMATIC DIAGRAM*

Dimension: [mm]

 □ 最大定格 : *MAXIMUM RATINGS* (at $T_c=25^\circ\text{C}$ unless otherwise specified)

	Item	Symbol	Condition	Rated Value	Unit
IGBT	コレクタ・エミッタ間電圧 Collector-Emitter Voltage	V_{CES}	G-E Short	1200	V
	ゲート・エミッタ間電圧 Gate-Emitter Voltage	V_{GES}	C-E Short	± 20	V
	コレクタ電流 Collector Current	I_C	DC $T_c=85^\circ\text{C}$	50	A
		I_{CP}	Pulse $\leq 1\text{ms}$	100	
	コレクタ損失 Collector Power Dissipation	P_C	$T_j=175^\circ\text{C}$	277	W
			$T_j=150^\circ\text{C}$	231	
FWD	繰り返しピーク逆電圧 Repetitive peak reverse voltage	V_{RRM}		1200	V
	順電流 Forward Current	I_F		50	A
		I_{FM}	Pulse $\leq 1\text{ms}$	100	
	最大接合温度 Maximum Junction Temperature	T_{jMAX}	瞬時動作(過負荷) Instantaneous Overload	175	$^\circ\text{C}$
	接合温度範囲 Junction Temperature Range	T_j		$-40\sim+150$	$^\circ\text{C}$
	保存温度範囲 Storage Temperature Range	T_{stg}		$-40\sim+125$	$^\circ\text{C}$
	絶縁耐圧 Isolation Voltage	V_{ISO}	Terminal to Base AC, 1minute	2,500	V (RMS)
締め付けトルク Mounting Torque	Module Base to Heatsink	F_{tor}	M6	3	N · m
	Busbar to Main Terminal		M5	2	

□ 電 氣 的 特 性 : **ELECTRICAL CHARACTERISTICS** (at $T_j=25^\circ\text{C}$ unless otherwise specified)

Characteristic		Symbol	Test Condition	Min.	Typ.	Max.	Unit	
IGBT	コレクタ遮断電流 Collector-Emitter Cut-Off Current	ICES	$V_{CE}=1200V, V_{GE}=0V$	—	—	1.0	mA	
	ゲート漏れ電流 Gate-Emitter Leakage Current	IGES	$V_{GE}=\pm 20V, V_{CE}=0V$	—	—	1.0	μA	
	コレクタ・エミッタ間飽和電圧 Collector-Emitter Saturation Voltage	VCE(sat.)	$I_c=50A, V_{GE}=15V$ (chip level)	$T_j=25^\circ\text{C}$	—	1.50	2.00	V
				$T_j=125^\circ\text{C}$	—	1.70	—	
				$T_j=150^\circ\text{C}$	—	1.80	—	
	ゲートしきい値電圧 Gate-Emitter Threshold Voltage	VGE(th.)	$V_{CE}=10V, I_c=1.7mA$	4.8	—	7.0	V	
	入力容量 Input Capacitance	Cies	$V_{CE}=25V, V_{GE}=0V, f=1MHz$	—	5.3	—	nF	
	出力容量 Output Capacitance	Coes		—	0.16	—		
	帰還容量 Reverse Transfer Capacitance	Cres		—	0.12	—		
	ゲート電荷量 Gate Charge	Qg	$V_{CC}=600V, I_c=50A, V_{GE}=-15\sim+15V$	—	550	—	nC	
スイッチング時間 Switching Time	上昇時間 Rise Time	tr	$V_{CC}=600V, L_s=38nH$ $I_c=50A$ Inductive Load $R_g=15\Omega$ $V_{GE}=\pm 15V$ $T_j=150^\circ\text{C}$	—	60	—	ns	
	ターンオン遅延時間 Turn-on Delay Time	td(on)		—	110	—		
	下降時間 Fall Time	tf		—	180	—		
	ターンオフ遅延時間 Turn-off Delay Time	td(off)		—	500	—		
順電圧 Peak Forward Voltage	VF	$I_F=50A, V_{GE}=0V$ (chip level)	$T_j=25^\circ\text{C}$	—	2.00	2.60	V	
			$T_j=125^\circ\text{C}$	—	1.98	—		
			$T_j=150^\circ\text{C}$	—	1.95	—		
逆回復時間 Reverse Recovery Time	trr	$V_{CC}=600V, L_s=38nH$ $I_c=50A$ Inductive Load $R_g=15\Omega$ $V_{GE}=\pm 15V$ $T_j=150^\circ\text{C}$	—	130	—	ns		
内部配線抵抗 Internal Lead Resistance	RCC+EE'	主端子—チップ間 / 1素子 Main Terminal - Chip / Per 1 Arm	—	—	1	m Ω		
内部インダクタンス Stray Inductance	LSCE	メイン端子3—2間 Main Terminal 3 - Main Terminal 2	—	30	—	nH		

 □ 熱 的 特 性 : **THERMAL CHARACTERISTICS**

Characteristic		Symbol	Test Condition	Min.	Typ.	Max.	Unit
熱抵抗 Thermal Resistance	IGBT	Rth(j-c)	Junction to Case Per 1 Arm (Tc測定点:チップ直下)	—	—	0.54	$^\circ\text{C}/\text{W}$
	FWD			—	—	0.97	
接触熱抵抗 Thermal Resistance	IGBT	Rth(c-f)	Case to heatsink Per 1 Arm Paste=1W/(m 2 °C)	—	0.10	—	
	FWD			—	0.17	—	

特性图 : CHARACTERISTICS CURVES

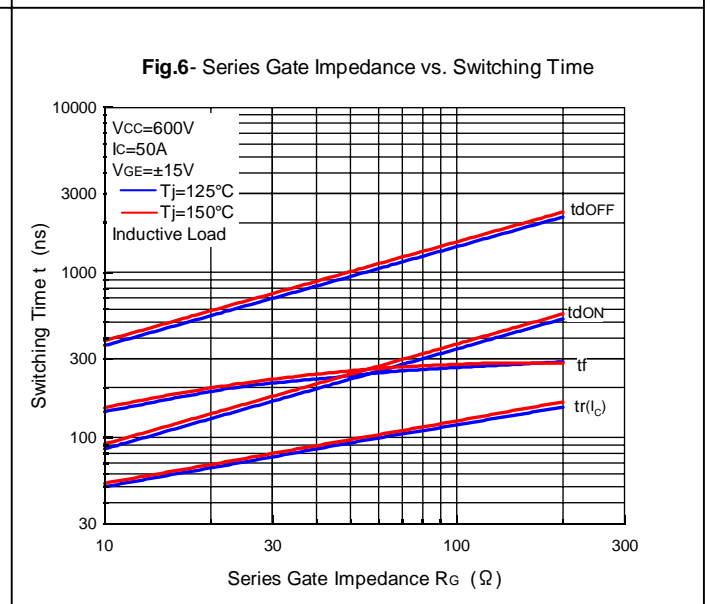
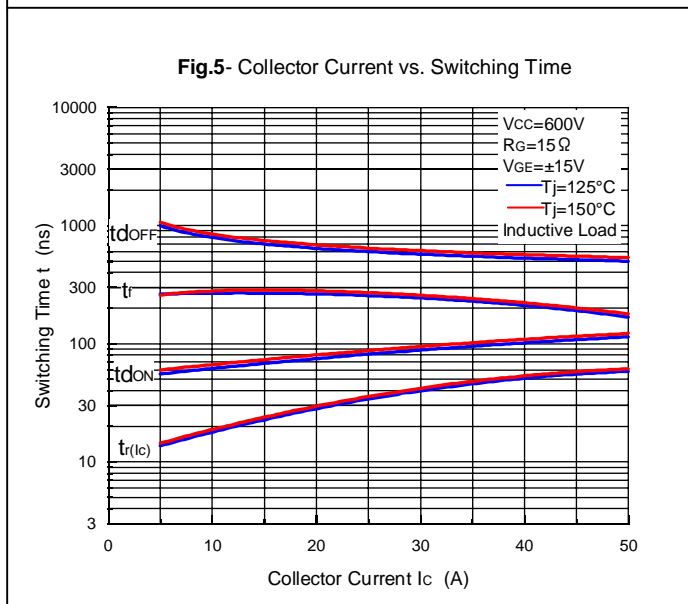
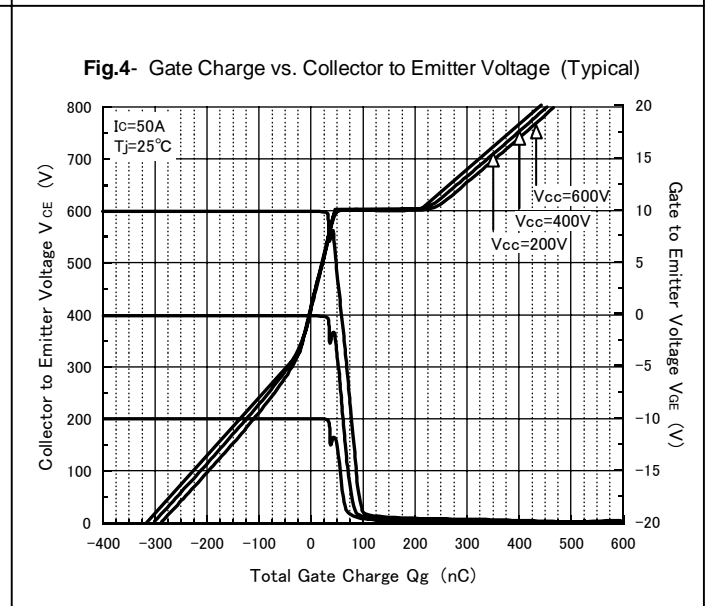
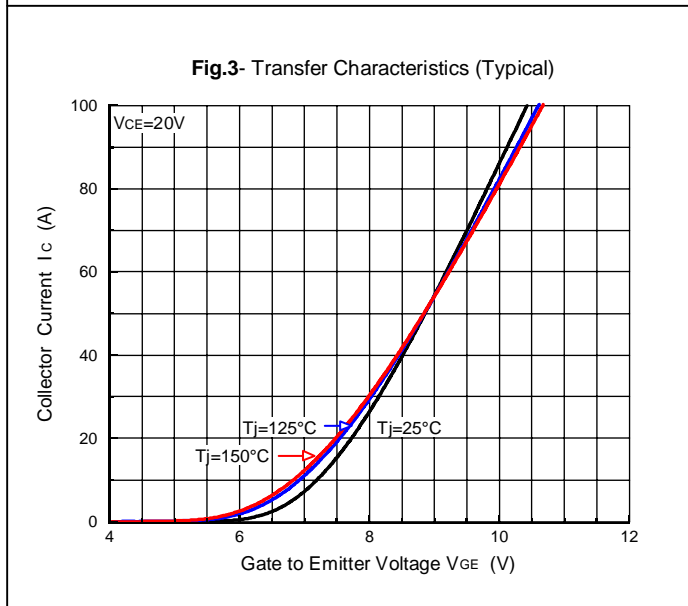
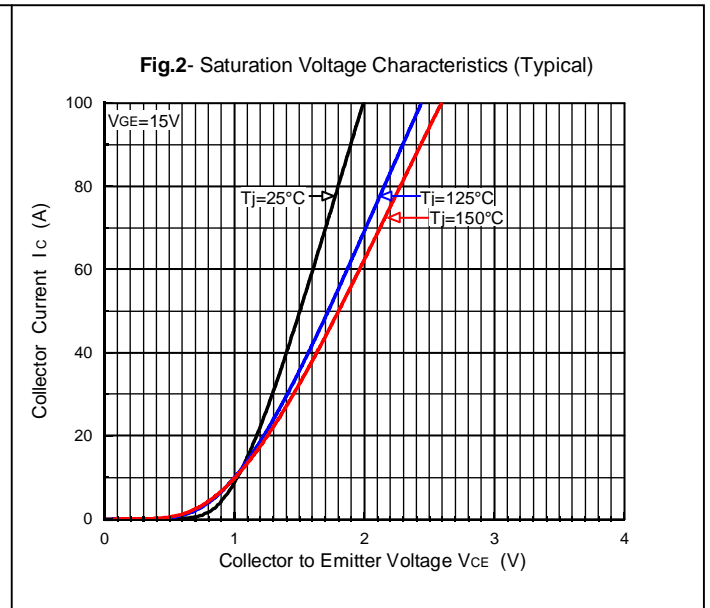
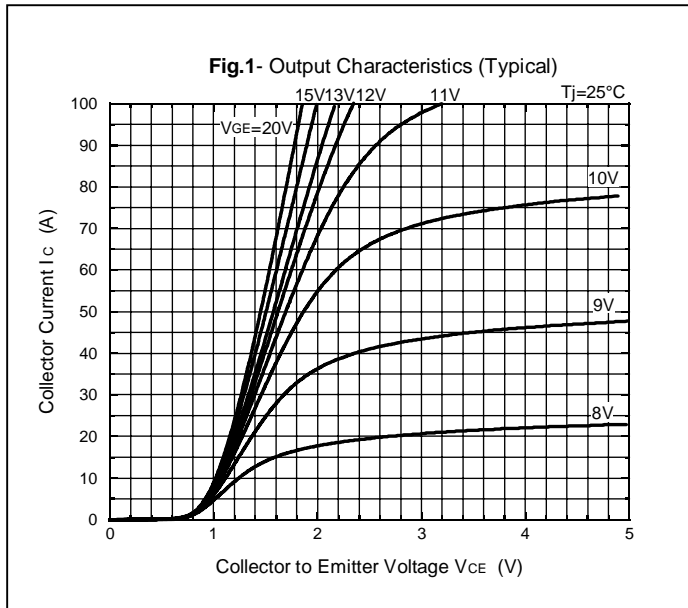

特性 : CHARACTERISTICS CURVES

