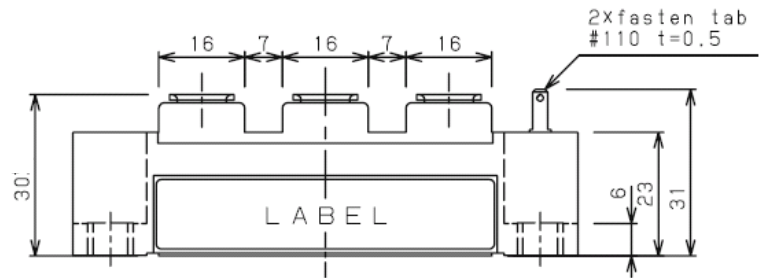
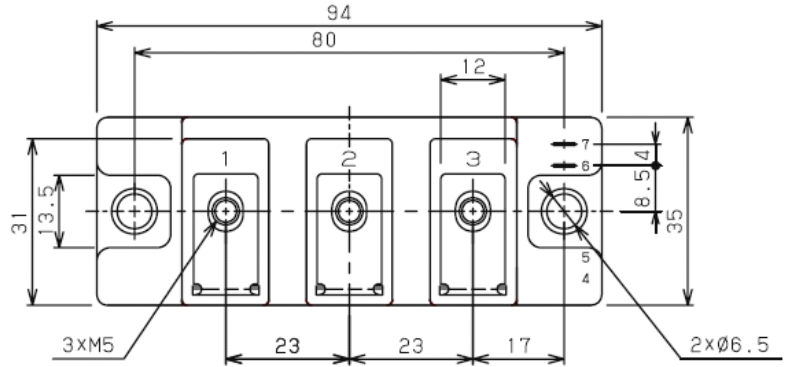
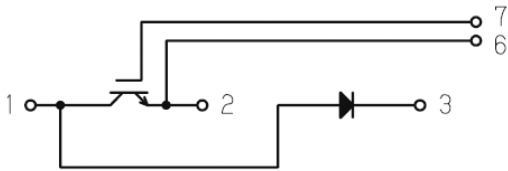

□ 回路図 : *CIRCUIT*

 □ 概略図 : *SCHEMATIC DIAGRAM*

Dimension: [mm]

 □ 最大定格 : *MAXIMUM RATINGS* (at  $T_c=25^\circ\text{C}$  unless otherwise specified)

Item		Symbol	Condition	Rated Value	Unit
IGBT	コレクタ・エミッタ間電圧 Collector-Emitter Voltage	$V_{CES}$	G-E Short	650	V
	ゲート・エミッタ間電圧 Gate-Emitter Voltage	$V_{GES}$	C-E Short	$\pm 20$	V
	コレクタ電流 Collector Current	$I_C$	DC $T_c=85^\circ\text{C}$	150	A
		$I_{CP}$	Pulse $\leq 1\text{ms}$	300	
コレクタ損失 Collector Power Dissipation	$P_C$	$T_j=175^\circ\text{C}$	536	W	
		$T_j=150^\circ\text{C}$	446		
FWD	繰り返しピーク逆電圧 Repetitive peak reverse voltage	$V_{RRM}$		650	V
	順電流 Forward Current	$I_F$		150	A
		$I_{FM}$	Pulse $\leq 1\text{ms}$	300	
最大接合温度 Maximum Junction Temperature		$T_{jMAX}$	瞬時動作(過負荷) Instantaneous Overload	175	$^\circ\text{C}$
接合温度範囲 Junction Temperature Range		$T_j$		$-40 \sim +150$	$^\circ\text{C}$
保存温度範囲 Storage Temperature Range		$T_{stg}$		$-40 \sim +125$	$^\circ\text{C}$
絶縁耐圧 Isolation Voltage		$V_{ISO}$	Terminal to Base AC, 1minute	2,500	V (RMS)
締め付けトルク Mounting Torque	Module Base to Heatsink	$F_{tor}$	M6	3	N · m
	Busbar to Main Terminal		M5	2	

□ 電 氣 的 特 性 : **ELECTRICAL CHARACTERISTICS** (at  $T_J=25^\circ\text{C}$  unless otherwise specified)

Characteristic		Symbol	Test Condition	Min.	Typ.	Max.	Unit	
IGBT	コレクタ遮断電流 Collector-Emitter Cut-Off Current	ICES	$V_{CE}=650V, V_{GE}=0V$	—	—	1.0	mA	
	ゲート漏れ電流 Gate-Emitter Leakage Current	IGES	$V_{GE}=\pm 20V, V_{CE}=0V$	—	—	1.0	$\mu\text{A}$	
	コレクタ・エミッタ間飽和電圧 Collector-Emitter Saturation Voltage	VCE(sat.)	$I_C=150A, V_{GE}=15V$ (chip level)	$T_J=25^\circ\text{C}$	—	1.45	1.95	V
				$T_J=125^\circ\text{C}$	—	1.65	—	
				$T_J=150^\circ\text{C}$	—	1.70	—	
	ゲートしきい値電圧 Gate-Emitter Threshold Voltage	VGE(th.)	$V_{CE}=10V, I_C=3mA$	4.8	—	7.0	V	
	入力容量 Input Capacitance	Cies	$V_{CE}=25V, V_{GE}=0V, f=1MHz$	—	12.5	—	nF	
	出力容量 Output Capacitance	Coes		—	0.5	—		
	帰還容量 Reverse Transfer Capacitance	Cres		—	0.4	—		
	ゲート電荷量 Gate Charge	Qg	$V_{CC}=300V, I_C=150A, V_{GE}=-15\sim+15V$	—	1275	—	nC	
スイッチング時間 Switching Time	上昇時間 Rise Time	tr	$V_{CC}=300V, L_s=38nH$ $I_C=150A$ Inductive Load $R_G=5.1\Omega$ $V_{GE}=\pm 15V$ $T_J=150^\circ\text{C}$	—	71	—	ns	
	ターンオン遅延時間 Turn-on Delay Time	td(on)		—	119	—		
	下降時間 Fall Time	tf		—	70	—		
	ターンオフ遅延時間 Turn-off Delay Time	td(off)		—	300	—		
順電圧 Peak Forward Voltage	V <sub>F</sub>	$I_F=150A, V_{GE}=0V$ (chip level)	$T_J=25^\circ\text{C}$	—	1.70	2.20	V	
			$T_J=125^\circ\text{C}$	—	1.60	—		
			$T_J=150^\circ\text{C}$	—	1.55	—		
逆回復時間 Reverse Recovery Time	t <sub>rr</sub>	$V_{CC}=300V, L_s=38nH$ $I_C=150A$ Inductive Load $R_G=5.1\Omega$ $V_{GE}=\pm 15V$ $T_J=150^\circ\text{C}$	—	140	—	ns		
内部配線抵抗 Internal Lead Resistance	RCC+EE'	主端子—チップ間 / 1素子 Main Terminal - Chip / Per 1 Arm	—	—	1	m $\Omega$		
内部インダクタンス Stray Inductance	LSCE	メイン端子3—2間 Main Terminal 3 - Main Terminal 2	—	30	—	nH		

 □ 熱 的 特 性 : **THERMAL CHARACTERISTICS**

Characteristic		Symbol	Test Condition	Min.	Typ.	Max.	Unit
熱抵抗 Thermal Resistance	IGBT	Rth(j-c)	Junction to Case Per 1 Arm (Tc測定点:チップ直下)	—	—	0.28	°C/W
	FWD			—	—	0.67	
接触熱抵抗 Thermal Resistance	IGBT	Rth(c-f)	Case to heatsink Per 1 Arm Paste=1W/(m <sup>2</sup> °C)	—	0.10	—	
	FWD			—	0.17	—	

特性图 : CHARACTERISTICS CURVES

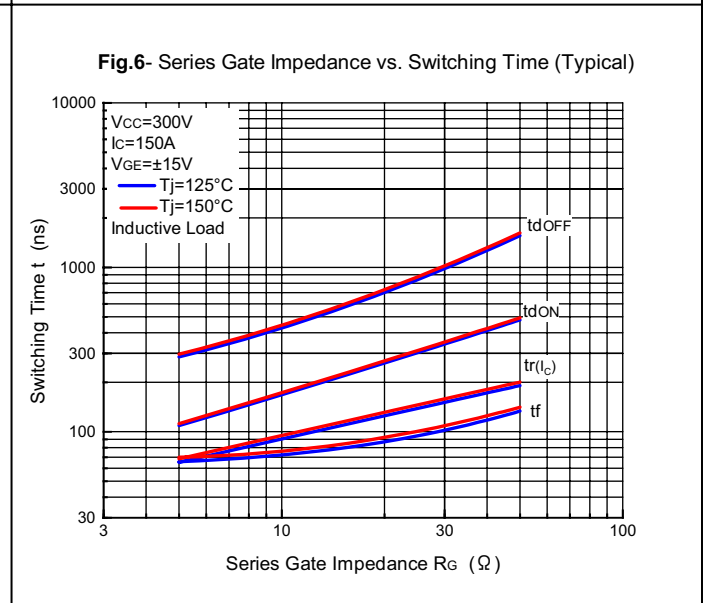
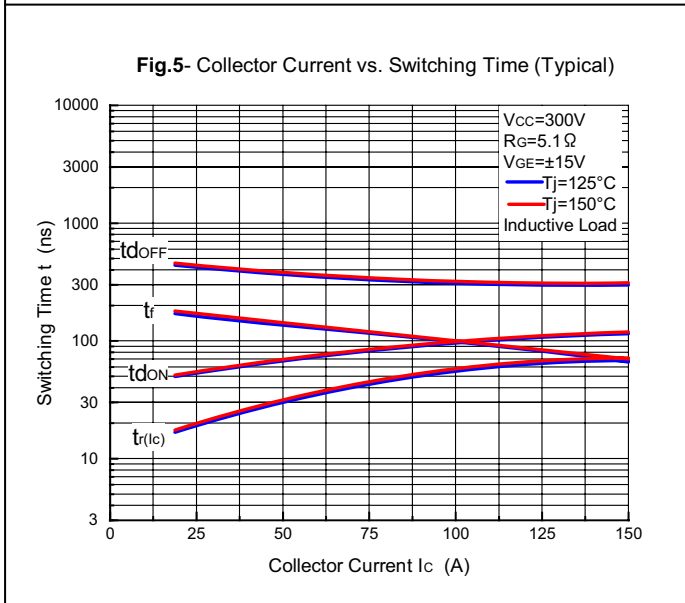
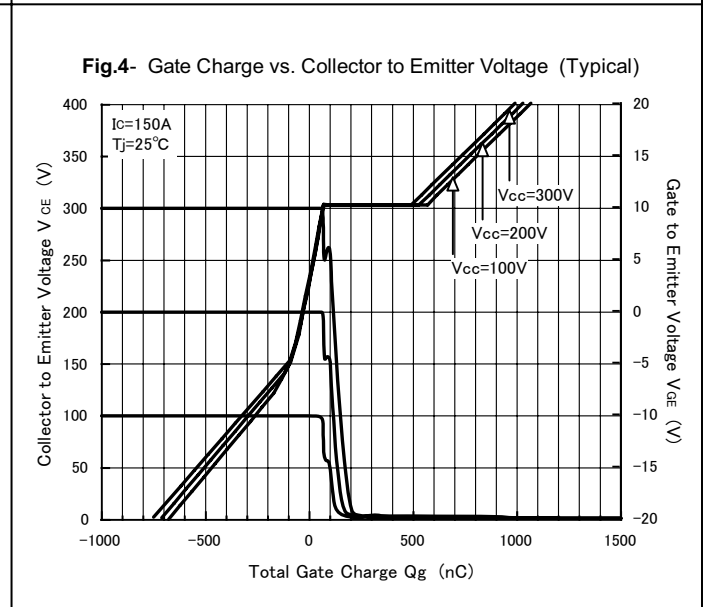
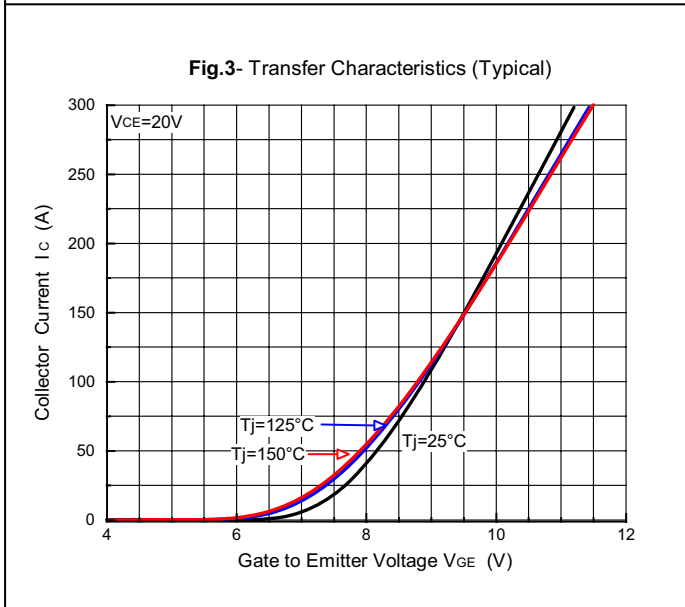
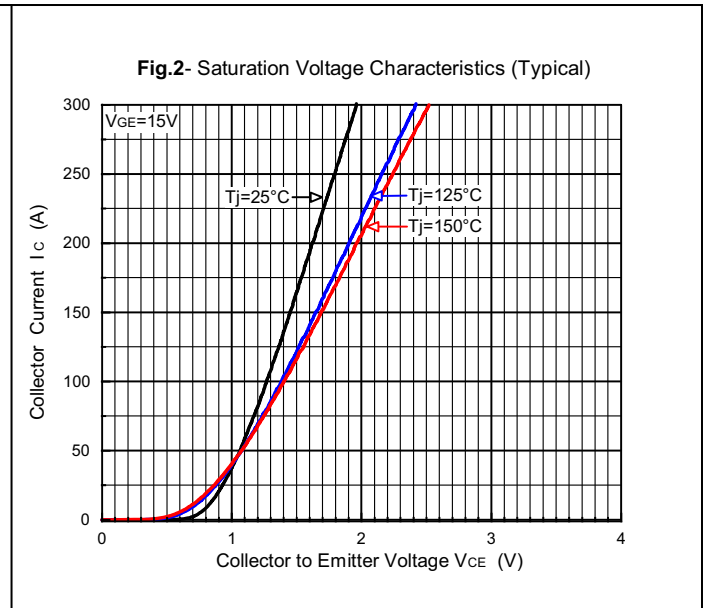
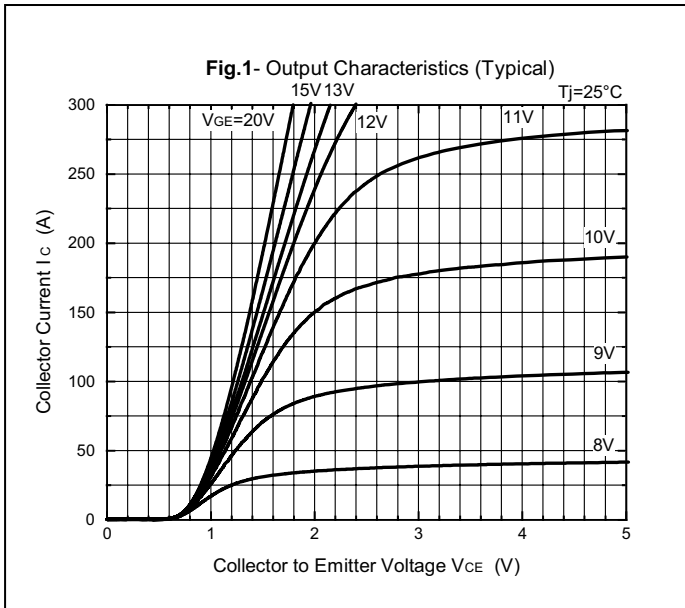

特性 : CHARACTERISTICS CURVES

