

# THYRISTOR

# 30A Avg 800 Volts

PDT308  
PDH308  
PCH308

回路図 CIRCUIT

外形寸法図 OUTLINE DRAWING

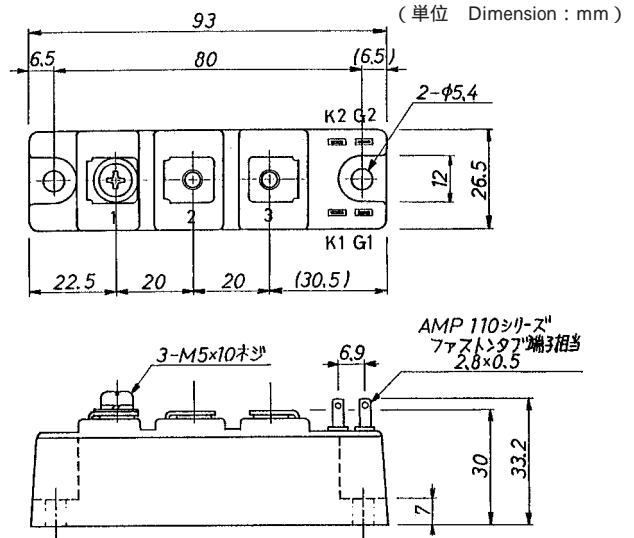
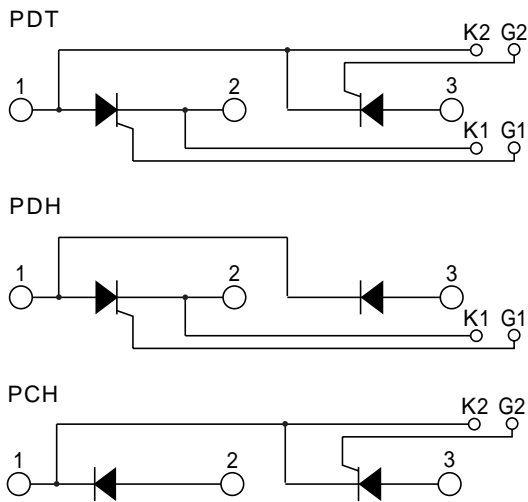

最大定格 Maximum Ratings

項目 Parameter	記号 Symbol	耐压クラス Grade		単位 Unit
		PDT308/PDH308/PCH308		
くり返しピークオフ電圧 Repetitive Peak Off-State Voltage	$V_{DRM}$	800		V
非くり返しピークオフ電圧 Non Repetitive Peak Off-State Voltage	$V_{DSM}$	960		V
くり返しピーク逆電圧 Repetitive Peak Reverse Voltage	$V_{RRM}$	800		V
非くり返しピーク逆電圧 Non Repetitive Peak Reverse Voltage	$V_{RSM}$	960		V

項目 Parameter	記号 Symbol	条件 Conditions	定格値 Max. Rated Value	単位 Unit		
平均整流電流 Average Rectified Output Current	$I_{\alpha(AV)}$	商用周波数 180° 通電 Half Sine Wave $T_c = 95$	30	A		
実効オン電流 RMS On-State Current	$I_{T(RMS)}$		47	A		
サージオン電流 Surge On-State Current	$I_{TSM}$	50Hz正弦半波, 1 サイクル, 非くり返し Half Sine Wave, 1Pulse, Non-Repetitive	600	A		
電流二乗時間積 I Squared t	$I^2t$	2 ~ 10ms	1800	$A^2s$		
臨界オン電流上昇率 Critical Rate of Rise of Turned-On Current	$di/dt$	$V_D = 2/3 V_{DRM}$ , $I_{TM} = 2 \cdot I_{\alpha}$ , $T_j = 125$ $I_G = 200mA$ , $di_G/dt = 0.2A/\mu s$	100	$A/\mu s$		
ピークゲート電力損失 Peak Gate Power	$P_{GM}$		5	W		
平均ゲート電力損失 Average Gate Power	$P_{G(AV)}$		1	W		
ピークゲート電流 Peak Gate Current	$I_{GM}$		2	A		
ピークゲート電圧 Peak Gate Voltage	$V_{GM}$		10	V		
ピークゲート逆電圧 Peak Gate Reverse Voltage	$V_{RGM}$		5	V		
動作接合温度範囲 Operating Junction Temperature Range	$T_{jw}$		- 40 ~ + 125			
保存温度範囲 Storage Temperature Range	$T_{stg}$		- 40 ~ + 125			
絶縁耐圧 Isolation Voltage	$V_{iso}$	端子 - ベース間, AC 1 分間 Terminal to Base, AC 1 min.	2000	V		
締付トルク Mounting Torque	ベース部 Mounting	F	サーマルコンパウンド塗布 Greased	M5	2.4 ~ 2.8	N·m
	主端子部 Terminal		M5	2.4 ~ 2.8	N·m	

電気的特性 Electrical Characteristics

項目 Parameter	記号 Symbol	条件 Conditions	特性値(最大) Maximum Value			単位 Unit
			最小 Min.	標準 Typ.	最大 Max.	
ピークオフ電流 Peak Off-State Current	$I_{DM}$	$T_j=125$ , $V_{DM}=V_{DRM}$			10	mA
ピーク逆電流 Peak Reverse Current	$I_{RM}$	$T_j=125$ , $V_{RM}=V_{RRM}$			10	mA
ピークオン電圧 Peak On-State Voltage	$V_{TM}$	$T_j=25$ , $I_{TM}=90A$			1.45	V
トリガゲート電流 Gate Current to Trigger	$I_{GT}$	$V_D=6V$ , $I_T=1A$	$T_j=-40$		200	mA
			$T_j=25$		100	mA
			$T_j=125$		50	mA
トリガゲート電圧 Gate Voltage to Trigger	$V_{GT}$	$V_D=6V$ , $I_T=1A$	$T_j=-40$		4	V
			$T_j=25$		2.5	V
			$T_j=125$		2	V
非トリガゲート電圧 Gate Non-Trigger Voltage	$V_{GD}$	$T_j=125$ , $V_D=2/3V_{DRM}$	0.25			V
臨界オフ電圧上昇率 Critical Rate of Rise of Off-State Voltage	$dv/dt$	$T_j=125$ , $V_D=2/3V_{DRM}$	500			V/ $\mu$ s
ターンオフ時間 Turn-Off Time	$t_q$	$T_j=125$ , $I_{TM}=I_o$ , $V_D=2/3V_{DRM}$ $dv/dt=20V/\mu$ s , $V_R=100V$ , $-di/dt=20A/\mu$ s		100		$\mu$ s
ターンオン時間 Turn-On Time	$t_{gt}$			6		$\mu$ s
遅れ時間 Delay Time	$t_d$	$T_j=25$ , $V_D=2/3V_{DRM}$ $I_G=200mA$ , $dig/dt=0.2A/\mu$ s		2		$\mu$ s
立上がり時間 Rise Time	$t_r$			4		$\mu$ s
ラッチング電流 Latching Current	$I_L$	$T_j=25$		100		mA
保持電流 Holding Current	$I_H$	$T_j=25$		50		mA
熱抵抗 Thermal Resistance	$R_{th(j-c)}$	接合部 - ケース間 Junction to Case			0.7	/W
接触熱抵抗 Thermal Resistance	$R_{th(c-f)}$	ケース - フィン間, サーマルコンパウンド塗布 Case to Fin, Greased			0.2	/W

質量...約155g  
Approximate Weight

1 アーム当りの値 Value Per 1 Arm.

オン電圧特性  
ON-STATE CURRENT VS. VOLTAGE

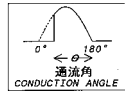
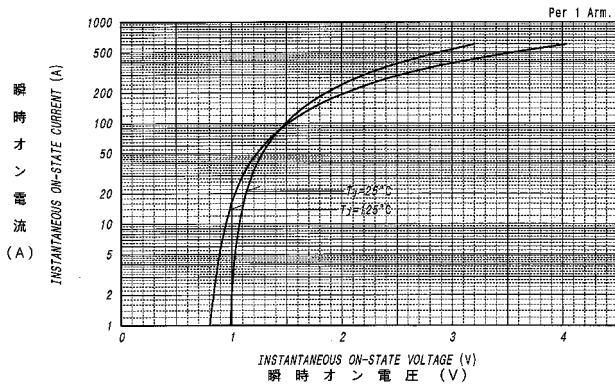

平均オン電力損失特性  
AVERAGE ON-STATE POWER DISSIPATION  
for SINUSOIDAL CURRENT WAVEFORM

平均オン電力損失 (W)

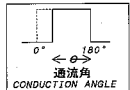
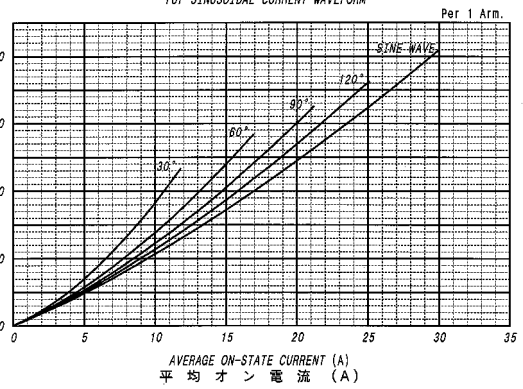

平均オン電力損失特性  
AVERAGE ON-STATE POWER DISSIPATION  
for RECTANGULAR CURRENT WAVEFORM

平均オン電力損失 (W)

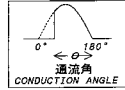
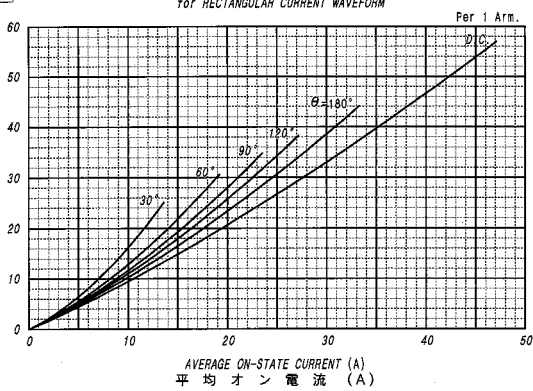

平均オン電流 - ケース温度定格  
AVERAGE ON-STATE CURRENT VS. CASE TEMPERATURE

平均オン電流 (A)

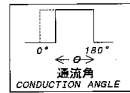
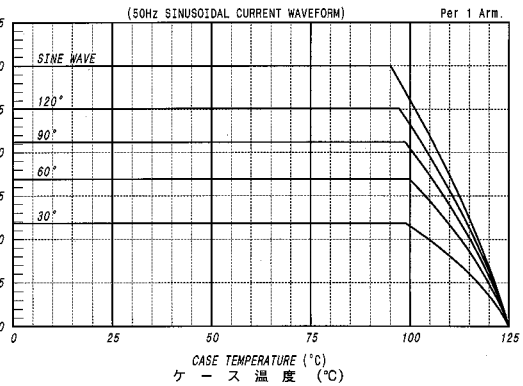

平均オン電流 - ケース温度定格  
AVERAGE ON-STATE CURRENT VS. CASE TEMPERATURE

平均オン電流 (A)

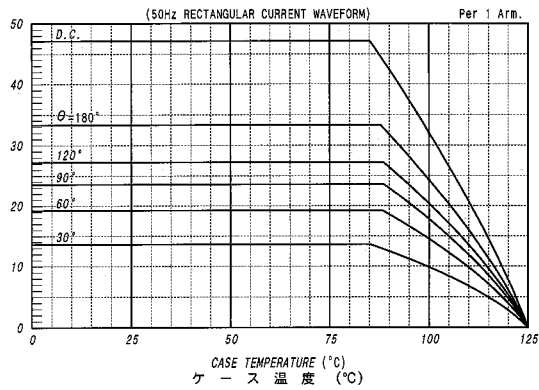

サージオン電流定格  
SURGE CURRENT RATINGS

サージオン電流 (A)

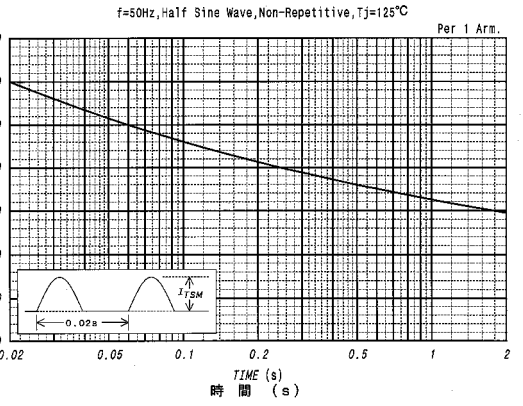

ゲート特性  
GATE CHARACTERISTICS

トリガゲート電圧 (V)

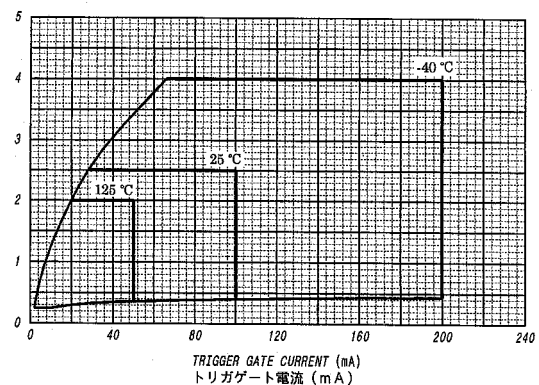

ゲート定格  
GATE RATINGS

ゲート電圧 (V)

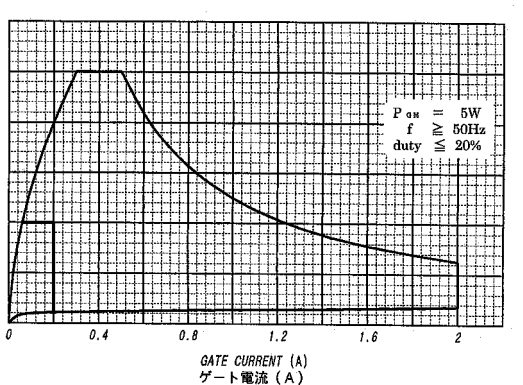

過渡熱抵抗特性  
MAXIMUM TRANSIENT THERMAL IMPEDANCE  
Junction to Case

Per 1 Arm.

