

THYRISTOR

150A Avg 800 Volts

PDT
PDH
PCH
PAT
PAH

1508

回路図 CIRCUIT

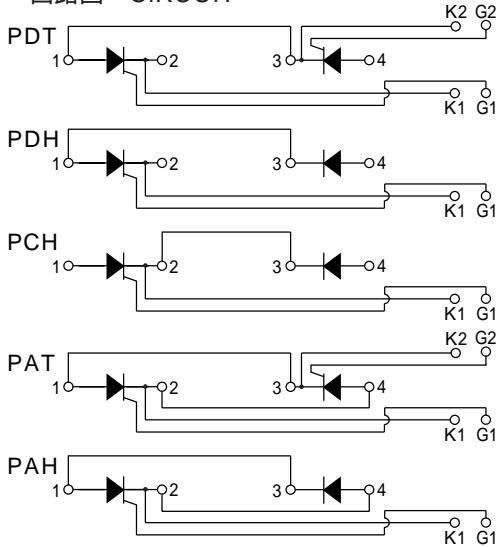

外形寸法図 OUTLINE DRAWING

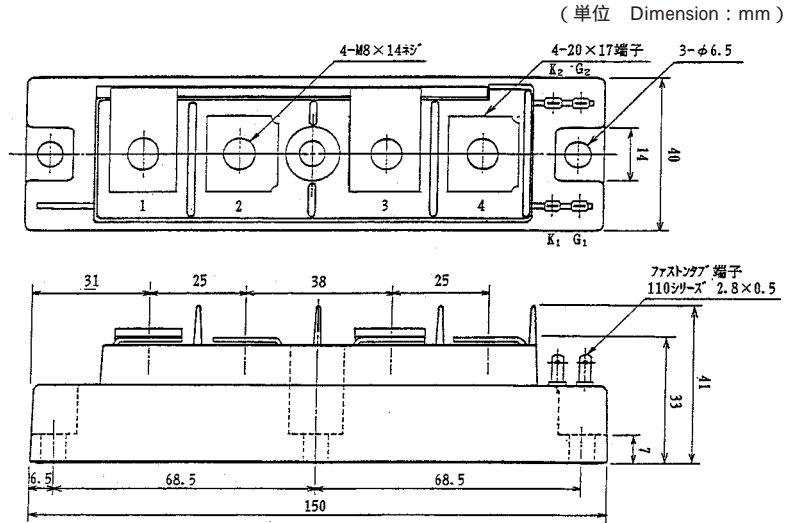

最大定格 Maximum Ratings

項目 Parameter	記号 Symbol	耐压クラス Grade		単位 Unit
		PDT1508/PDH1508/PCH1508/PAT1508/PAH1508		
くり返しピークオフ電圧 Repetitive Peak Off-State Voltage	V_{DRM}	800		V
非くり返しピークオフ電圧 Non Repetitive Peak Off-State Voltage	V_{DSM}	900		V
くり返しピーク逆電圧 Repetitive Peak Reverse Voltage	V_{RRM}	800		V
非くり返しピーク逆電圧 Non Repetitive Peak Reverse Voltage	V_{RSM}	900		V

項目 Parameter	記号 Symbol	条件 Conditions	定格値 Max. Rated Value	単位 Unit	
平均整流電流 Average Rectified Output Current	$I_{\alpha(AV)}$	商用周波数 180° 通電 Half Sine Wave $T_c = 78$	150	A	
実効オン電流 RMS On-State Current	$I_{T(RMS)}$		235	A	
サージオン電流 Surge On-State Current	I_{TSM}	50Hz正弦半波, 1 サイクル, 非くり返し Half Sine Wave, 1Pulse, Non-Repetitive	3200	A	
電流二乗時間積 I Squared t	I^2t	2 ~ 10ms	51200	A^2s	
臨界オン電流上昇率 Critical Rate of Rise of Turned-On Current	di/dt	$V_D = 2/3 V_{DRM}$, $I_{TM} = 2 \cdot I_{\alpha}$, $T_j = 125$ $I_G = 300mA$, $di_G/dt = 0.2A/\mu s$	100	$A/\mu s$	
ピークゲート電力損失 Peak Gate Power	P_{GM}		5	W	
平均ゲート電力損失 Average Gate Power	$P_{G(AV)}$		1	W	
ピークゲート電流 Peak Gate Current	I_{GM}		2	A	
ピークゲート電圧 Peak Gate Voltage	V_{GM}		10	V	
ピークゲート逆電圧 Peak Gate Reverse Voltage	V_{RGM}		5	V	
動作接合温度範囲 Operating Junction Temperature Range	T_{jw}		- 40 ~ + 125		
保存温度範囲 Storage Temperature Range	T_{stg}		- 40 ~ + 125		
絶縁耐圧 Isolation Voltage	V_{iso}	端子 - ベース間, AC 1 分間 Terminal to Base, AC 1 min.	2000	V	
締付トルク Mounting Torque	ベース部 Mounting	サーマルコンパウンド塗布 Greased	M6	2.5 ~ 3.5	N·m
	主端子部 Terminal		M8	9.0 ~ 10.0	N·m

電気的特性 Electrical Characteristics

項目 Parameter	記号 Symbol	条件 Conditions	特性値(最大) Maximum Value			単位 Unit
			最小 Min.	標準 Typ.	最大 Max.	
ピークオフ電流 Peak Off-State Current	I_{DM}	$T_j=125$, $V_{DM}=V_{DRM}$			15	mA
ピーク逆電流 Peak Reverse Current	I_{RM}	$T_j=125$, $V_{RM}=V_{RRM}$			15	mA
ピークオン電圧 Peak On-State Voltage	V_{TM}	$T_j=25$, $I_{TM}=450A$			1.28	V
トリガゲート電流 Gate Current to Trigger	I_{GT}	$V_D=6V$, $I_T=1A$	$T_j=-40$		300	mA
			$T_j=25$		150	mA
			$T_j=125$		80	mA
トリガゲート電圧 Gate Voltage to Trigger	V_{GT}	$V_D=6V$, $I_T=1A$	$T_j=-40$		5	V
			$T_j=25$		3	V
			$T_j=125$		2	V
非トリガゲート電圧 Gate Non-Trigger Voltage	V_{GD}	$T_j=125$, $V_D=2/3V_{DRM}$	0.25			V
臨界オフ電圧上昇率 Critical Rate of Rise of Off-State Voltage	dv/dt	$T_j=125$, $V_D=2/3V_{DRM}$	500			V/ μ s
ターンオフ時間 Turn-Off Time	t_q	$T_j=125$, $I_{TM}=I_o$, $V_D=2/3V_{DRM}$ $dv/dt=20V/\mu$ s , $V_R=100V$, $-di/dt=20A/\mu$ s		100		μ s
ターンオン時間 Turn-On Time	t_{gt}			6		μ s
遅れ時間 Delay Time	t_d	$T_j=25$, $V_D=2/3V_{DRM}$ $I_G=300mA$, $di/dt=0.2A/\mu$ s		2		μ s
立上がり時間 Rise Time	t_r			4		μ s
ラッチング電流 Latching Current	I_L	$T_j=25$		100		mA
保持電流 Holding Current	I_H	$T_j=25$		60		mA
熱抵抗 Thermal Resistance	$R_{th(j-c)}$	接合部 - ケース間 Junction to Case			0.25	/W
接触熱抵抗 Thermal Resistance	$R_{th(c-f)}$	ケース - フィン間, サーマルコンパウンド塗布 Case to Fin, Greased			0.1	/W

質量...約480g
Approximate Weight

1 アーム当りの値 Value Per 1 Arm.

オン電圧特性
ON-STATE CURRENT VS. VOLTAGE

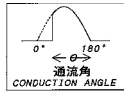
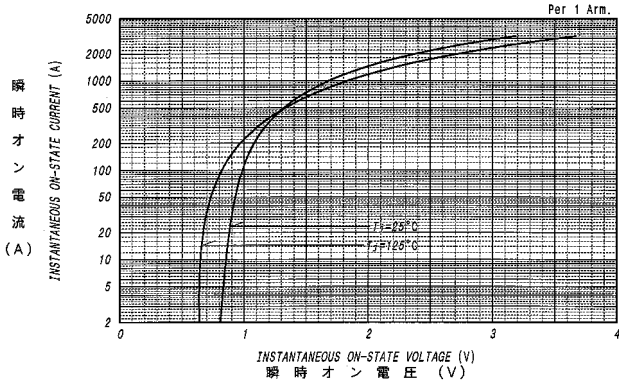

平均オン電力損失特性
AVERAGE ON-STATE POWER DISSIPATION
for SINUSOIDAL CURRENT WAVEFORM

平均オン電力損失 (W)

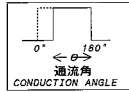
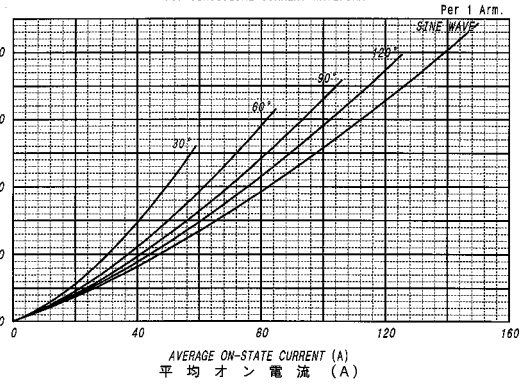

平均オン電力損失特性
AVERAGE ON-STATE POWER DISSIPATION
for RECTANGULAR CURRENT WAVEFORM

平均オン電力損失 (W)

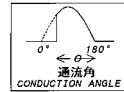
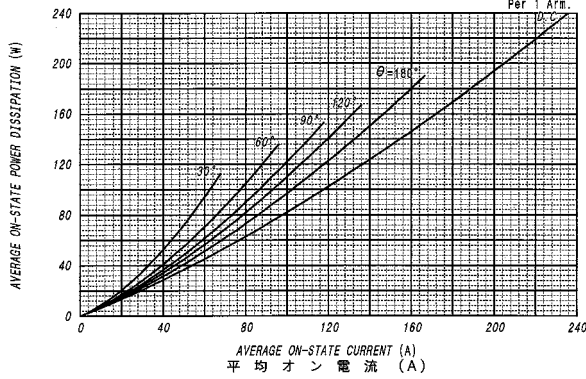

平均オン電流 - ケース温度定格
AVERAGE ON-STATE CURRENT VS. CASE TEMPERATURE

平均オン電流 (A)

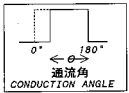
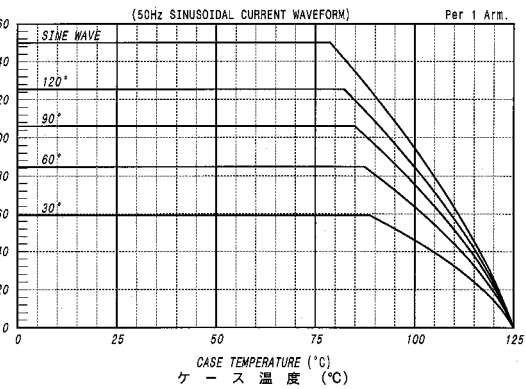

平均オン電流 - ケース温度定格
AVERAGE ON-STATE CURRENT VS. CASE TEMPERATURE

平均オン電流 (A)

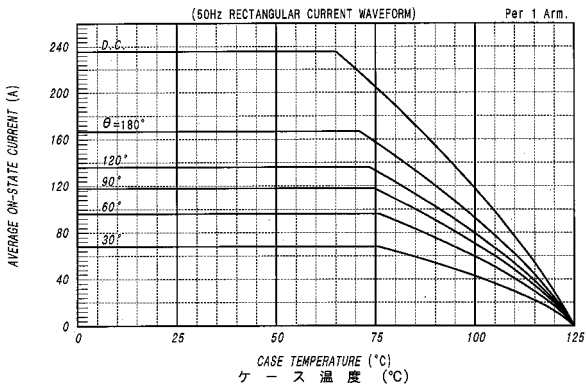

サージオン電流定格
SURGE CURRENT RATINGS

f=50Hz, Half Sine Wave, Non-Repetitive, Tj=125°C

サージオン電流 (A)

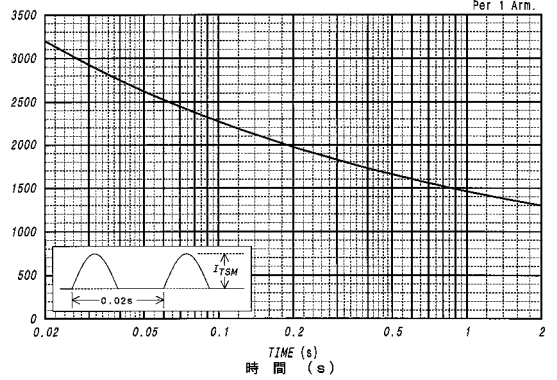

ゲート特性
GATE CHARACTERISTICS

トリガゲート電圧 (V)

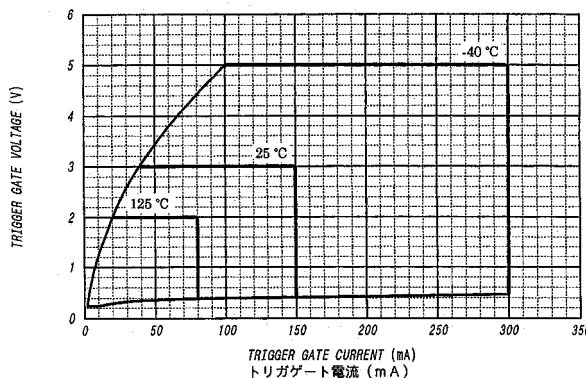

ゲート定格
GATE RATINGS

ゲート電圧 (V)

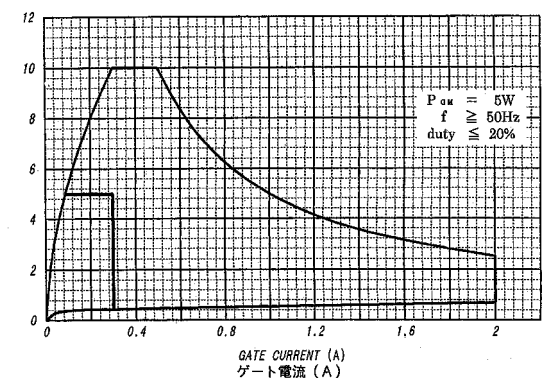

過渡熱抵抗特性
 MAXIMUM TRANSIENT THERMAL IMPEDANCE
 Junction to Case

Per 1 Arm.

